

# Predicting Strain Levels in Air-dried Wood using near Infrared Spectroscopy

Authors: Fei Guo, Clemens Altaner

**Date:**

Publication No: SWP-T020

---

# TABLE OF CONTENTS

EXECUTIVE SUMMARY .....	1
INTRODUCTION .....	2
METHODS.....	3
RESULTS .....	6
Effect of strain on NIR spectra .....	6
Stress relaxation and modulus of elasticity (MOE) .....	7
MFA .....	7
Consistency of peak position measurement .....	8
NIR band shifts induced by strain or stress .....	9
Discussion .....	10
Band shift rates and MoE/MFA.....	10
Prediction of growth-strain using NIR .....	11
CONCLUSION.....	12
ACKNOWLEDGEMENTS .....	13
REFERENCES .....	13

## Disclaimer

This report has been prepared by University of Canterbury for Forest Growers Research Ltd subject to the terms and conditions of a research fund agreement dated 1 July 2015.

The opinions and information provided in this report have been provided in good faith and on the basis that every endeavour has been made to be accurate and not misleading and to exercise reasonable care, skill and judgement in providing such opinions and information.

Under the terms of the Services Agreement, University of Canterbury's liability to Forest Growers Research Ltd in relation to the services provided to produce this report is limited to the value of those services. Neither University of Canterbury nor any of its employees, contractors, agents or other persons acting on its behalf or under its control accept any responsibility to any person or organisation in respect of any information or opinion provided in this report in excess of that amount.

## EXECUTIVE SUMMARY

To investigate the possibility of measuring strain using near infrared (NIR) spectroscopy, spectra of air-dried radiata wood samples were collected while under different levels of tension stress. The spectral changes were analysed by data manipulations including normalization and calculating second derivative spectra. Band shifts were calculated by curve fitting. The effects of stress relaxation, modulus of elasticity (MoE) and microfibril angle (MFA) on band shifts were studied as well.

In this study, consistent spectral changes caused by mechanical strain were observed. Peaks at  $6286\text{ cm}^{-1}$  and  $6465\text{ cm}^{-1}$  in the second derivative spectra shifted to higher wavenumbers with the increase of strain levels. There was stress relaxation during the spectra collecting process but the effect was negligible. The standard deviation of peak position measurement was less than  $0.162\text{ cm}^{-1}$ . Band shifts at  $6286\text{ cm}^{-1}$  of 10 samples all showed good linear relationship with strain. On average, 1000 microstrains (a value exceeded in eucalypt logs) can induce a band shift of  $1\text{ cm}^{-1}$  at  $6286\text{ cm}^{-1}$ . This correlation indicated that it is possible to predict strain or stress in logs using NIR spectroscopy. But further studies are needed. MOE and MFA were not found to be correlated with NIR band shift rates at  $6286\text{ cm}^{-1}$  but more samples are required for a definitive conclusion.

# INTRODUCTION

Growth-stress is recognized as one of the major issues preventing plantation eucalypts from high valued wood product uses as they cause splitting, warp, checking and other problems to logs and sawn timber (Yang & Waugh, 2001). However, current methods to measure growth-stress are time-consuming and destructive. Spectroscopic methods like infrared and Raman spectroscopy have shown potential to predict stress levels in cellulose fibres and plant tissues (Eichhorn *et al.*, 2001; Gierlinger *et al.*, 2006). An important advantage of near infrared (NIR) spectrometers is their portability and ability to take spectra from surfaces of solid samples. The disadvantage is the complexity of the measured signal. Theoretical considerations and a literature review on how infrared spectroscopy could be used to assess strain in solid wood have been published in a separate report for SWP (SWP-T002). In the present report, NIR spectra of dry wood samples were collected under tensile stress to investigate whether it is possible to measure strain using NIR spectroscopy.

## METHODS

10 radiata pine (*Pinus radiata*) wood samples with a length of 80 mm in the longitudinal direction were cut from an air-dried board. The width was about 16 mm and the thickness was less than 1 mm. The moisture content of the samples was equilibrated at 22°C and 50% relative humidity.

### 1) Modulus of elasticity (MoE) (tension) and relaxation behaviour

Strain gauges were glued onto the samples with instant adhesive (Loctite 454, Australia) and connected to a strain-meter (TC-31K, Tokyo Sokki Kenkyujo, Japan). The strain-meter provided more accurate sample strain measurements compared to assessing the movement of the cross bar of the testing rig.

A universal mechanical test machine (Instron, USA) was used for tensile tests of those samples in the elastic region with a loading rate of 1 mm/min. Relaxation of one sample was characterized at a tensile force of 300 N for 300 seconds.

The loading rate for MoE measurements was 0.2 mm/min. For each sample, tensile tests were conducted three times and the third tensile test was stopped at extensions of 0.05, 0.10, 0.15, 0.20 and 0.25 mm within the elastic zone. The strain-meter was set 0 in the relaxed state and strain readings were recorded when the tests were stopped. The relationship between force and strain was used to calculate MoE.

### 2) NIR measurements of wood under tension

To study the effect of strain on NIR spectra, a test rig (Figure 1) had been built based on a toolmakers vice. Two clamps with a width of ~25 mm were attached to the fixed and sliding components of the toolmakers vice. The sliding clamp is driven by a screw to stretch the sample. The displacement was measured with a dial gauge (Starrett 3809MA, USA) with a graduation of 0.01 mm and range of 0.8 mm. The test rig was fitted into the sample compartment of a NIR spectrometer (Bruker Tensor 37, Germany). Transmission spectra were averages of 128 scans recorded at 8 cm<sup>-1</sup> interval.

A circular NIR polarizer (oriented silver particles embedded in soda lime glass, CODIXX, Germany) with a diameter of 20.8 mm was used to polarize the incident beam parallel to the longitudinal direction of the sample. The light beam is ~10 mm in diameter.

Transmission NIR spectra of the 10 radiata pine samples were collected at displacements of 0, 0.03, 0.06, 0.10, 0.14, 0.17, 0.20, 0.24 mm. The strain of the samples was also recorded with the help of the strain gauge.

Spectra were analysed with the R software package. The original spectra were normalized using the standard normal variate (SNV) method in the region of 6000 to 7200 cm<sup>-1</sup>. Second derivative spectra were calculated using Savitzky-Golay smoothing filters with a filter length of 39 datapoints. A 'slope' spectrum can be calculated as the rate of intensity change dependent on the strain level at a given wavenumber. The 'slope' spectra reveal information about band shifts and intensity changes in spectra (Altaner *et al.*, 2014). The slope values in the present research were the average of the linear regression coefficients of the 10 samples.

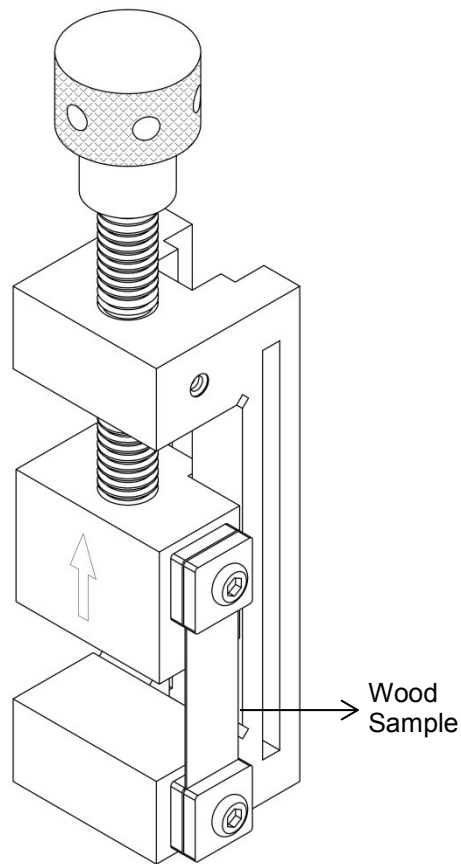

Figure 1 Test rig based on a toolmakers tool

### 3) Peak position calculation

In order to determine the peak position and calculate band shifts, peaks were fitted with a Gaussian function. Troughs or negative peaks in a second derivative spectrum correspond to signals in the original spectra. For example the signal at around  $6290\text{ cm}^{-1}$  was fitted using 21 data points as in Figure 2. The peak position was obtained from the fitted function.

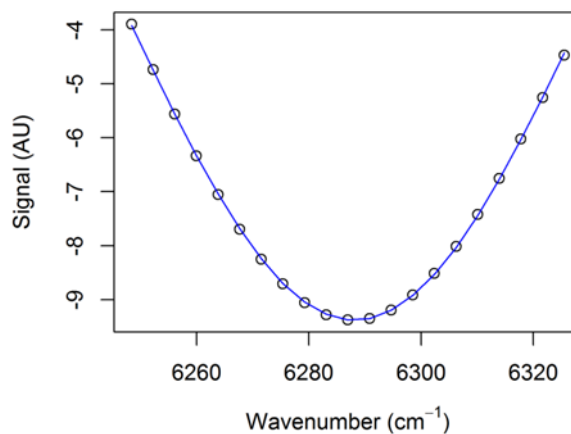

Figure 2 Peak fitting method using Gaussian function

#### 4) Microfibril angle measurements

Cellulose microfibrils in the S2 layer of secondary wood cell walls are oriented in an angle with respect to the axial fibre direction. This is referred to as the microfibril angle (MFA). The MFA will affect the molecular strain of cellulose molecules. It was measured by X-ray diffraction (XRD) to study whether the effect of MFA on molecular strain is detectable.

Diffraction patterns were obtained with a X-ray diffractometer (SuperNova, Rigaku, Japan) using Cu K $\alpha$  radiation with a wavelength of 1.54 Å. Samples were positioned at a distance of 70 mm from the detector with the fibre axis perpendicular to the beam. Chi-diffraction profiles were extracted between the 2theta angle range from 21° to 24°. The MFA was calculated according to Cave & Robinson (1998).

# RESULTS

## Effect of strain on NIR spectra

'Slope' spectra reflect the rate of change in signal intensity with regard to the strain level. At frequencies where the 'slope' values are close to 0, the signal is not consistently affected by mechanical stretching. On the contrary, a 'slope' value not equal to 0 reveals signals which are influenced by strain. The spectral region below 4500  $\text{cm}^{-1}$  is noisy due to the high absorption of the optics (Figure 3). The main spectral changes caused by mechanical strain were found in two regions: 6000 ~ 6600  $\text{cm}^{-1}$  and 4500 ~ 5500  $\text{cm}^{-1}$ . The subtle changes in the NIR spectra can also be seen in the raw spectra after standard variate normalization at 6450  $\text{cm}^{-1}$  (Figure 4).

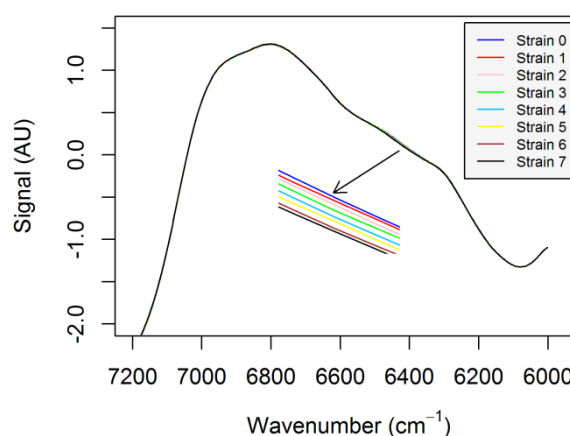
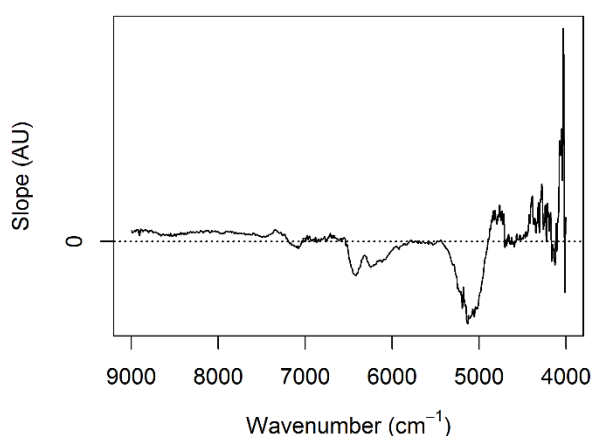

Figure 1 Averaged slope spectra of 10 radiata samples

Figure 2 Normalized NIR spectra at 8 strain levels

The wavenumber range from 6000 to 7000  $\text{cm}^{-1}$  is dominated by the first overtones of OH groups. Higher wavenumbers are assigned to free water and weakly bonded OH groups, while lower wavenumbers belongs to OH groups involved in strong hydrogen bonds (Schwanninger *et al.*, 2011). Second derivative spectra can resolve some overlapped signals. Figure 5 shows that the signals at around 6465  $\text{cm}^{-1}$  and 6286  $\text{cm}^{-1}$  shifted to higher frequency as the strain level increased. The peak at 6465  $\text{cm}^{-1}$  might be assigned to the stretching of O3–H3···O5 intrachain H-bonded OH group (Watanabe *et al.*, 2006). Note: the elongation of H-bonds strengthened the OH bond, resulting in a blue shift of the signal.

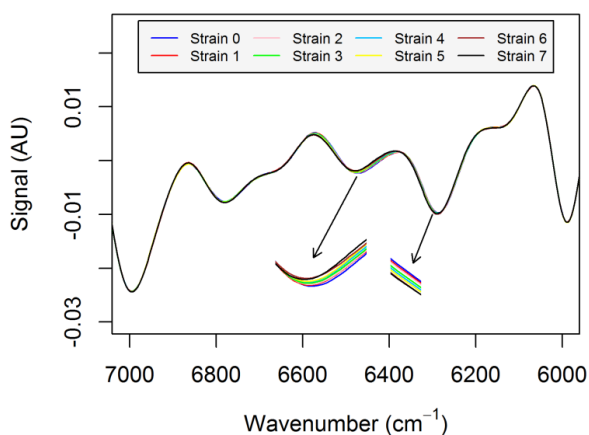

Figure 3 Band shifts at 6465  $\text{cm}^{-1}$  and 6286  $\text{cm}^{-1}$



## Stress relaxation and modulus of elasticity (MOE)

The tensile tests need to be stopped to allow NIR spectra collection. This can lead to stress relaxation (creep behaviour) which has been reported to be a significant factor with thin, microtomed wood sections (Altaner *et al.*, 2014). The stress relaxation effect can be seen in Figure 6. After 300 seconds, the tensile force reduced from 300 N to 294.6 N; which was 98.2% of the original force. The stress retained 98.8% after 60 seconds, roughly the time needed to acquire a spectrum. Therefore, the effect of stress relaxation on NIR spectra collection was negligible.

The MoE of the 10 samples ranged from 9.1 GPa to 12.5 GPa with a mean value of 10.82 GPa and a standard deviation of 1.08 GPa. Although these samples were cut from a single board, the observed variation in MoE demonstrated the inhomogeneity of wood. Wood properties vary greatly from latewood to earlywood and from pith to bark.

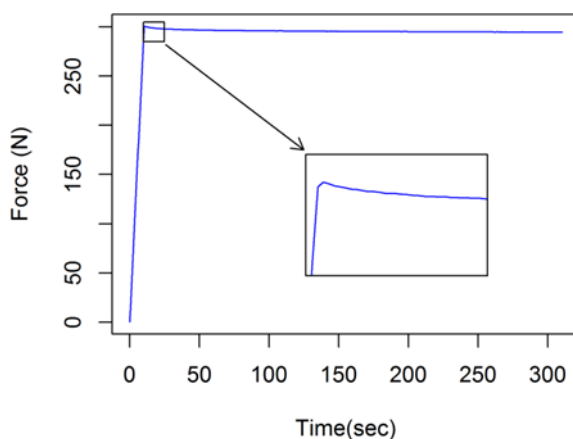

Figure 6 Relaxation of a radiata sample

## MFA

The MFA was correlated with the band shift to investigate the effect of MFA on NIR band shifts caused by mechanical strain. Figure 7 shows the diffraction pattern of a sample. The strongest signal arose from 002 plane of crystalline cellulose, i.e. the distance between the sheets of cellulose chains in the crystal. This crystal plane is oriented parallel to the cellulose chain. Therefore the width of this reflection is related to the MFA and its distribution (Evans, 1999). The 002 azimuthal diffraction profiles (Figure 8) were analysed to calculate MFA. The MFA of the radiata samples ranged from 5° to 10° and averaged 7.06°.

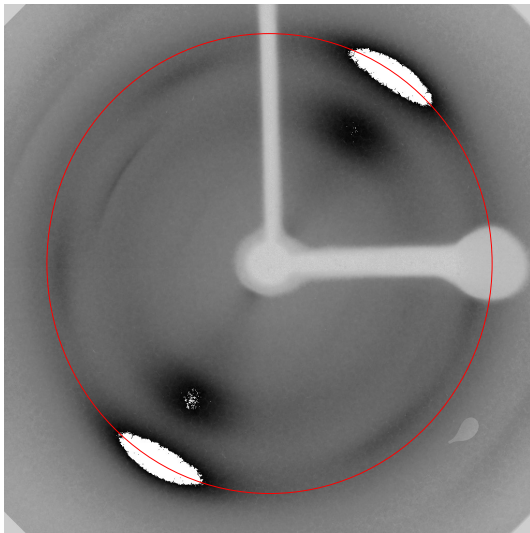

Figure 4 X ray diffraction pattern of radiata. Red: 002 azimuthal profile

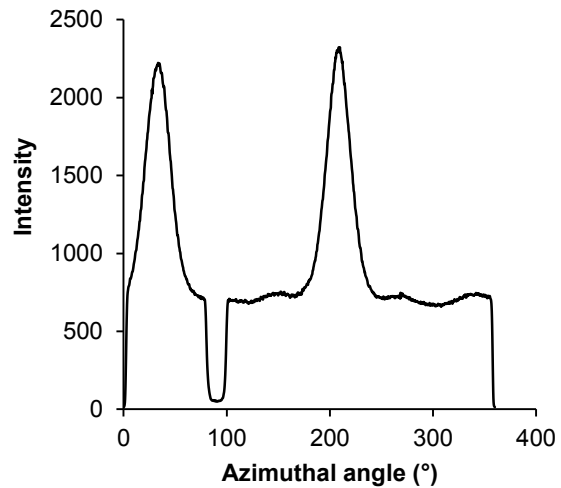

Figure 5 002 azimuthal diffraction intensity profile

## Consistency of peak position measurement

The  $6286\text{ cm}^{-1}$  signal was chosen to analyse the band shifts in more detail. The accuracy of determining the band position was checked by analysing 5 spectra of the same sample collected consecutively from the same position. These measurements were repeated for 4 samples. The standard deviation in determining the peak position ranged from  $0.120\text{ cm}^{-1}$  to  $0.162\text{ cm}^{-1}$  (Table 1). It is worth noticing that there was variation between the peak positions of those four samples. Analysis of Variance confirmed that there were significant differences between those samples (Table 2). This variation might come from different residual stress levels or different chemical composition of the samples.

Table 1 Repeatability of determining the peak position at a relaxed state

Sample	Spectrum 1	Spectrum 2	Spectrum 3	Spectrum 4	Spectrum 5	Mean	Standard Deviation
1	6285.746	6285.774	6285.806	6285.846	6285.537	6285.742	0.120
2	6286.586	6286.344	6286.469	6286.267	6286.393	6286.412	0.122
3	6285.773	6285.848	6286.082	6285.695	6285.751	6285.830	0.151
4	6285.835	6285.642	6285.443	6285.829	6285.736	6285.697	0.162

Table 2 Variance analysis

Source of Variation	SS	df	MS	F	P-value	F crit
Between Samples	1.658	3	0.553	28.078	1.303E-06	3.239
Within Samples	0.315	16	0.020			
Total	1.973	19				

## NIR band shifts induced by strain or stress

Band shift rate with respect to strain for the 6286  $\text{cm}^{-1}$  band was obtained by fitting a linear model (Figure 9). The results are summarised in Table 3, including the MOE and MFA values. The coefficient of determination ( $r^2$ ) indicated that there was a strong linear relationship between peak position and strain. The slope of the linear model represents the peak position changing rate with respect to strain. The average slope was  $1.04 \times 10^{-3} \text{ cm}^{-1}/\mu\epsilon$  for radiata pine wood. It means that an elongation of 0.1% (1000  $\mu\epsilon$ ) of the wood samples induces a band shift of  $1.04 \text{ cm}^{-1}$ .

The slope should be the same for all samples if macroscopic strain is directly converted into molecular strain of cellulose. However, values ranged from  $8.34 \times 10^{-4}$  to  $1.58 \times 10^{-3}$  (SD of  $2.11 \times 10^{-4}$ ), with one sample behaving quite different. Strain relaxation between cellulose fibrils or on the anatomical scale as well as differences in cellulose orientation (MFA) could contribute to this variation. Another contribution could be the accuracy of the peak position measurements.

Table 3 Summary of linear regressions between band positions and strain

Sample	Slope	$r^2$	MFA	MOE
1	8.99E-04	0.976	5.00	11.5
2	1.02E-03	0.971	5.00	12.5
3	1.58E-03	0.986	6.50	11.4
4	1.05E-03	0.922	-	11.8
5	8.34E-04	0.931	10.00	9.6
6	1.04E-03	0.972	10.00	11.0
7	1.12E-03	0.992	8.25	11.1
8	8.73E-04	0.981	6.00	9.1
9	1.01E-03	0.887	6.75	9.7
10	9.52E-04	0.961	6.00	10.5
Mean	1.04E-03	0.958	7.06	10.8
SD	2.11E-04	0.034	1.93	1.1

Elasticity of native cellulosic materials varies. It was reported that, for various cellulose fibre types, the 1095  $\text{cm}^{-1}$  Raman band shift rate with respect to strain is different but the value with respect to stress is invariant (Eichhorn *et al.*, 2001). With the forces and sample dimensions known, stress can be calculated. Band shifts of all the samples were plotted against stress and a linear regression between them was built (Figure 10). The  $r^2$  is 0.817, which indicates a fairly linear relationship. Using this model, we can predict the stress levels from the band shifts.

The slope in this study was  $82 \text{ cm}^{-1}/\text{GPa}$ , which is higher compared to the Raman band shift rate ( $-6.1 \text{ cm}^{-1}/\text{GPa}$ ) of single wood fibres (Gierlinger *et al.*, 2006). One contributor to the difference is the porous nature of wood. The stress in this study was calculated using the area of the sample, which is much greater than the true cell wall area. Neither have changes in the chemical composition (ie true cellulose cross sectional area) been considered. Another factor was that Raman spectroscopy monitors stronger covalent cellulose skeletal bonds which are stronger than the hydrogen bonded hydroxyl groups observed by NIR; in fact their band shift is in the opposite direction.

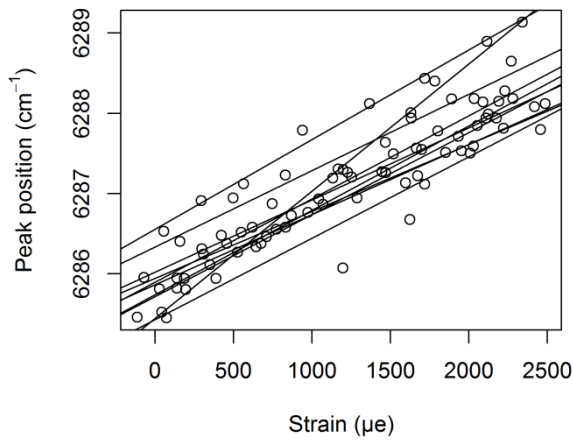

Figure 6 Linear relationships between peak positions and strain levels

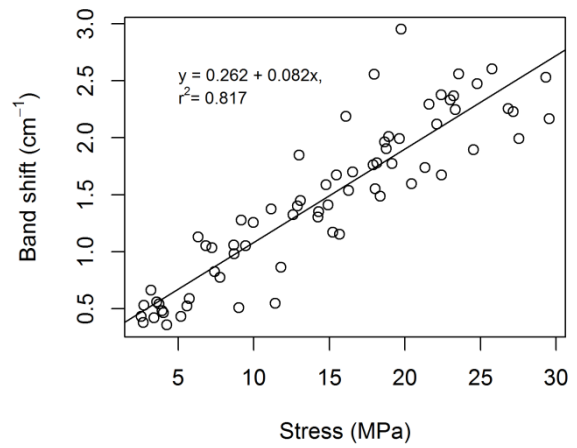

Figure 7 Linear model between band shifts and stress

## Discussion

### Band shift rates and MoE/MFA

Stiffness refers to the ability to resist deformation. Studies with Raman spectroscopy have shown that the shift rate with respect to stress is constant. According to equation (1), band shift rates with respect to strain will be proportional to the stiffness of wood sample (MoE).

$$\text{MoE} = d\sigma/d\varepsilon = d\sigma/(d(\Delta\nu)) \times (d(\Delta\nu))/d\varepsilon, \quad (1)$$

Where  $\sigma$  is the stress,  $\Delta\nu$  is the band shift and  $\varepsilon$  is the strain (Eichhorn & Young, 2001).

The relationship between band shift rate and MoE was plotted in Figure 8. For the observed range (9-12.5 GPa) no strong influence of MoE on the band shift could be observed. A sample set spanning a wider MoE range could yield more insight. The same can be said for the influence of MFA on the rate of the shift of the 6286  $\text{cm}^{-1}$  band (Figure 9). Assuming a chemical bond is in the cellulose chain direction, the molecular strain of the bond when the sample is pulled along the fibre axis will be controlled by  $\cos(\text{MFA})$ ; i.e. the differences in deformation between a MFA of  $5^\circ$  and  $10^\circ$  will be only 1.14%. The effect on band shift rate is insignificant at low MFA.

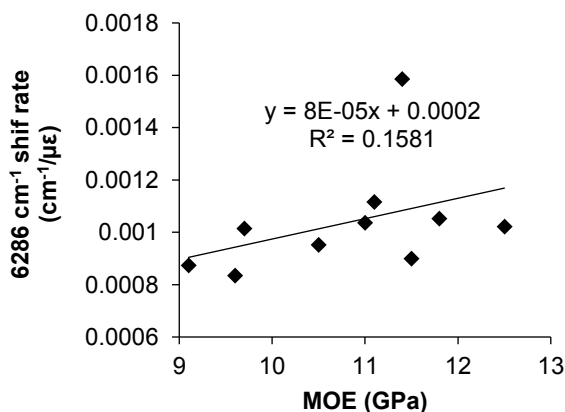

Figure 8 Effect of MoE on band shift rate

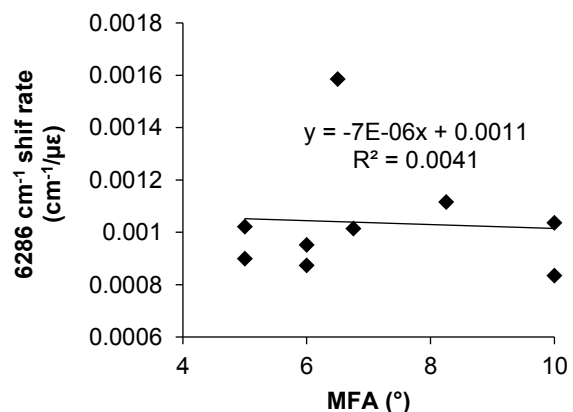

Figure 9 Effect of MFA on band shift rate

## Prediction of growth-strain using NIR

The good linear relationship between band shift and strain (Figure 10) implies that it is possible to measure strain in dry wood using NIR spectroscopy. An average shift of the  $6286\text{ cm}^{-1}$  band of  $\sim 1\text{ cm}^{-1}$  per 1000 microstrains suggests that the determination of the band position ( $\sim 0.14\text{ cm}^{-1}$ ) is accurate enough to assess band shifts due to growth-strain. Growth-strain was found to reach several thousand macrostrains in eucalyptus logs. Some issues need further study to clarify if NIR is able to assess growth-strain in logs.

Firstly, moisture is a crucial factor in NIR spectroscopy. Equilibrated air-dry wood samples were used in this study. Free water signals are at higher wavenumbers, and might not affect the band at  $6286\text{ cm}^{-1}$ . Secondly, only the surface of logs can be probed by NIR. This requires to obtain spectra in reflectance mode rather than in transmission. This is possible but the accuracy of the equipment needs to be determined. Thirdly, growth-strain as well as chemical composition is known to vary around and along stems. Therefore the sampling strategy is likely to require averaging of multiple measurements. Fourthly, considering commercial harvesting and transport of logs (i.e. shipping debarked logs) might cause the log surface to dry below fibre saturation point inducing drying stresses.

Currently the NIR measurements are performed in transmission which is obviously not feasible for solid wood applications. These are laboratory experiments which establish if it is possible in principle to measure the peak position (strain) of cellulose bonds in wood by NIR. Transmission mode was chosen due to the good quality of the spectra. In practice measurements need to be done in reflectance. In the lab this is possible with a fibre-optics probe – and UoC are working on this. In a practical application we would either want to use a handheld NIR device or a NIR camera. These have the ability to measure larger areas. However the issue with these devices is that they have a narrower band width – implying that we need to observe band shifts in a spectral region which these detectors can cover. Furthermore the spectral resolution might not be high enough. In essence it is still unclear on the best way forward with NIR either multiple small areas or a single large area.

## CONCLUSION

1. Consistent spectral changes due to molecular deformations have been found by NIR spectroscopy. Spectral changes caused by tension were mainly in two regions: 6000 - 6600  $\text{cm}^{-1}$  and 4500 - 5500  $\text{cm}^{-1}$ .
2. Stress relaxation during the spectra collecting process but was negligible for dry wood samples of the used thickness.
3. The standard deviation of peak position measurement was less than 0.162  $\text{cm}^{-1}$  for radiata pine in this study. At a relaxed state larger variation in the peak locations between different samples was observed.
4. Band shifts at 6286  $\text{cm}^{-1}$  have a good linear relationship with strain, a requirement for measuring growth-strain in wood. But further research is needed.
5. MOE and MFA did not correlate to NIR band shifts at 6286  $\text{cm}^{-1}$ . Further studies with more samples spanning a wider range of MOE and MFA values are required.

## ACKNOWLEDGEMENTS

This research project is financially supported by the Ministry of Business, Innovation & Employment (MBIE) – Specialty Wood Partnership of New Zealand. I would also like to thank Chinese Scholarship Council (CSC) for supporting my study in University of Canterbury.

## REFERENCES

- Altaner, C. M., L. H. Thomas, A. N. Fernandes, & M. C. Jarvis. (2014). How cellulose stretches: synergism between covalent and hydrogen bonding. *Biomacromolecules*, 15(3), 791-798.
- Cave, I., & W. Robinson. (1998). *Interpretation of (002) diffraction arcs by means of a minimalist model*. Paper presented at the Microfibril angle in wood. International Association of Wood Anatomists, University of Canterbury, New Zealand.
- Eichhorn, S., J. Sirichaisit, & R. Young. (2001). Deformation mechanisms in cellulose fibres, paper and wood. *Journal of Materials Science*, 36(13), 3129-3135.
- Eichhorn, S. J., & R. J. Young. (2001). The Young's modulus of a microcrystalline cellulose. [journal article]. *Cellulose*, 8(3), 197-207. doi: 10.1023/a:1013181804540
- Evans, R. (1999). A variance approach to the X-ray diffractometric estimation of microfibril angle in wood. *Appita Journal*, 52(4), 283-289.
- Gierlinger, N., M. Schwanninger, A. Reinecke, & I. Burgert. (2006). Molecular changes during tensile deformation of single wood fibers followed by Raman microscopy. *Biomacromolecules*, 7(7), 2077-2081. doi: 10.1021/bm060236g
- Schwanninger, M., J. C. Rodrigues, & K. Fackler. (2011). A review of band assignments in near infrared spectra of wood and wood components. *Journal of Near Infrared Spectroscopy*, 19(5), 287.
- Watanabe, A., S. Morita, & Y. Ozaki. (2006). Temperature-Dependent Structural Changes in Hydrogen Bonds in Microcrystalline Cellulose Studied by Infrared and Near-Infrared Spectroscopy with Perturbation-Correlation Moving-Window Two-Dimensional Correlation Analysis. *Applied Spectroscopy*, 60(6), 611-618.
- Yang, J. L., & G. Waugh. (2001). Growth stress, its measurement and effects. *Australian Forestry*, 64(2), 127-135.